

Technische Informationen

Normen und Bestellangaben

TECHNISCHE INFORMATIONEN

Übersicht Türdrücker

Übersicht Komponenten

Bestellhilfe Komponenten

Bestellangaben | Standardbelegungen

Türdrücker

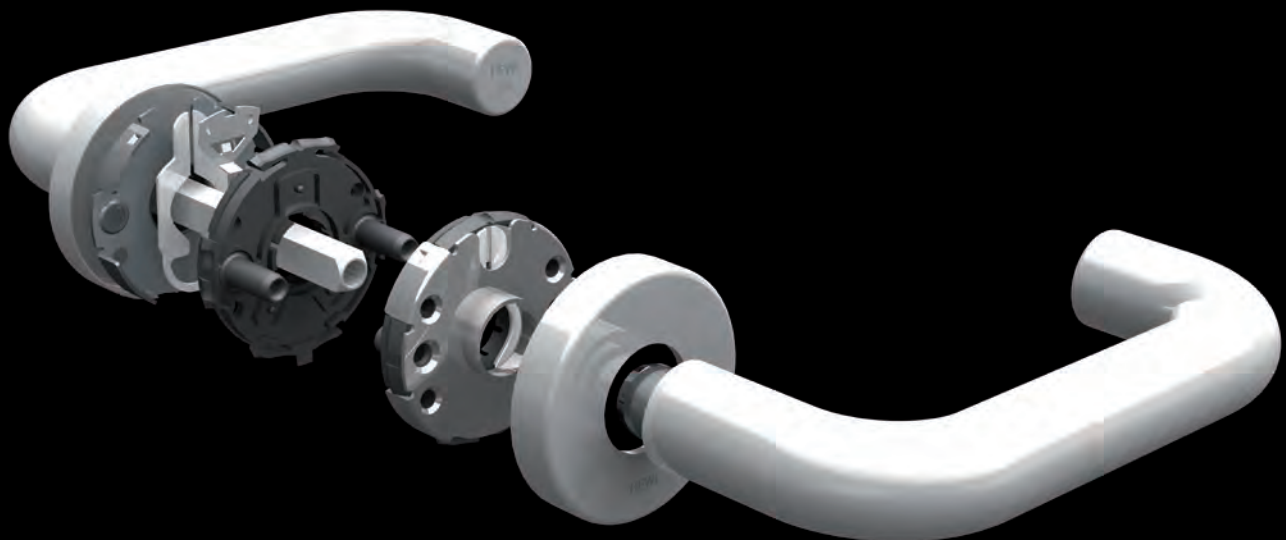

SYSTEM 111 POLYAMID | EDITION MATT



Modell 111...



Modell 111.23...



Modell 114.23...



Modell 115.23R



SYSTEM 162 POLYAMID | EDITION MATT



Modell 162.21P...



Modell 165.21P...

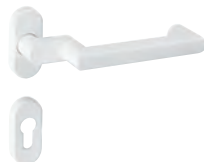

Modell 166.21P...



MINI POLYAMID | EDITION MATT



Modell 162.21P...M



Lieferbar bis 31.03.2025
Modell 111.23P...M



Lieferbar bis 31.03.2025
Modell 251.21PBM

BICOLOR POLYAMID | EDITION MATT Lieferbar bis 31.03.2025



Modell 111.23P...



Modell 162.21P...



Modell 251.21PB

KNÖPFE POLYAMID | EDITION MATT



Modell 122.23...



Modell 123.23...



Modell 138...

SYSTEM 111



Modell 111X...



Modell 112X...



Modell 113X...



SYSTEM 162



Modell 162X...



Modell 165X...



Modell 166X...



MINI EDELSTAHL



Modell 162X...M



Modell 271XAM



Modell 271XPM



Lieferbar bis 31.03.2025

Modell 111XAM

BICOLOR SERIE 270

Lieferbar bis 31.03.2025



Modell 271XP

SERIE 270



Modell 271X...



Modell 272X...



Modell 273X...



Modell 274XA...

SERIE 170 Lieferbar bis 31.03.2025



Modell 173X



Modell 174X



KNOPF-HALBGARNITUREN



Modell 106X...



Modell 107X...



Modell 108X...



Modell 109X...



Modell 276X...



Modell 277X...

TÜRDRÜCKER SYSTEM 111

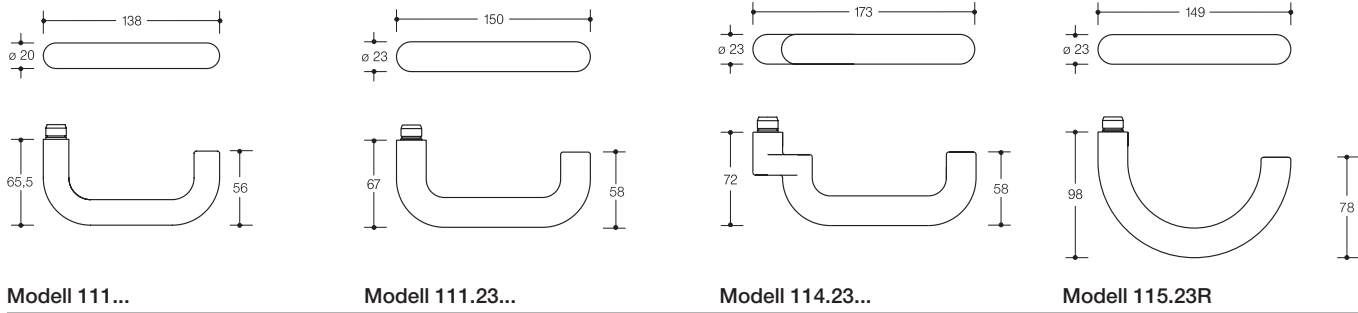

TÜRDRÜCKER SYSTEM 162

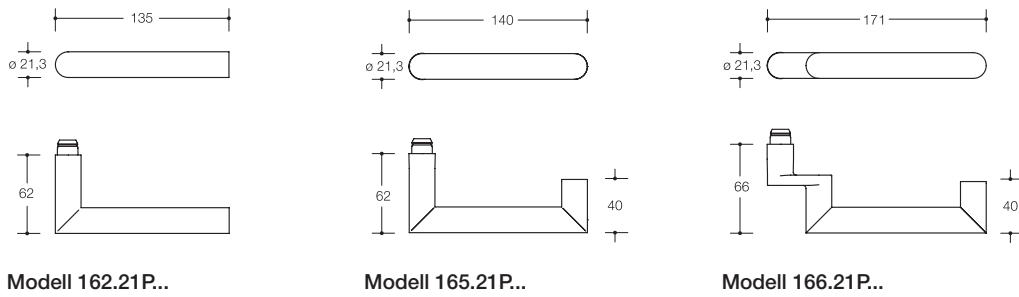

KNÖPFE

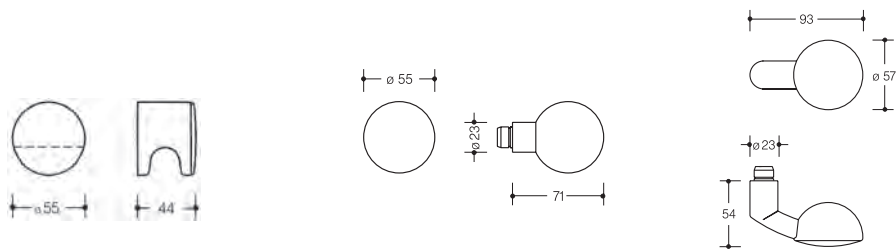

BICOLOR

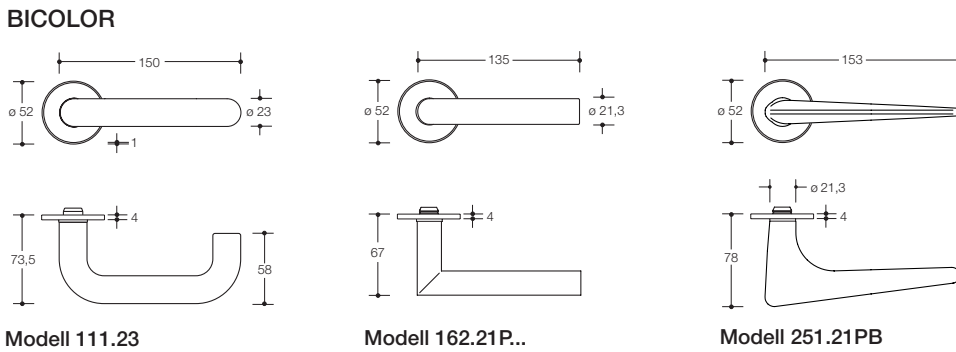

MINI

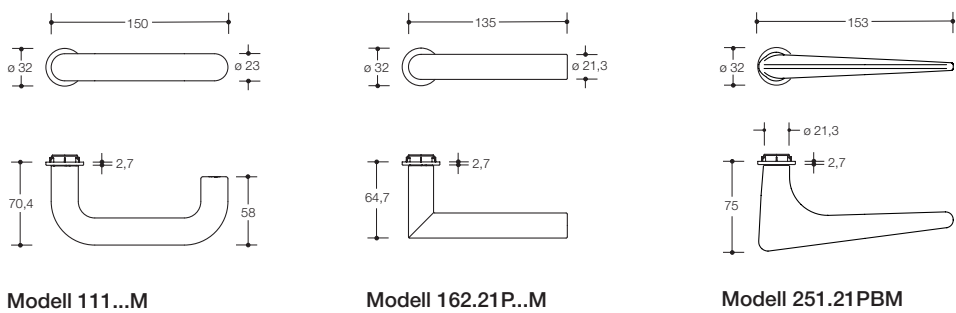

ROSETTEN

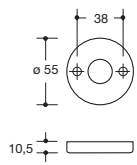

Drückerrosette 305...

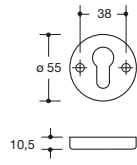

Schlüsselrosette 306...

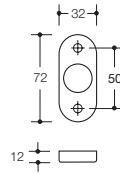

Drückerrosette 315...

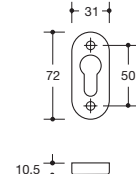

Schlüsselrosette 316...

SCHUTZROSETTEN

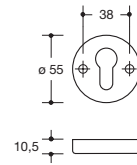

Schutzrosette 306...

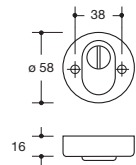

Schutzrosette mit Zylinderabdeckung 306...Z...

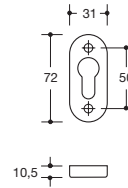

Schutzrosette 316...

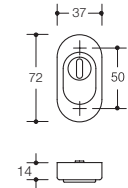

Schutzrosette mit Zylinderabdeckung 316...Z...

SCHILDER

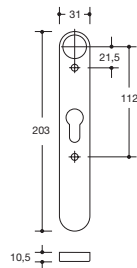

Schild 217...

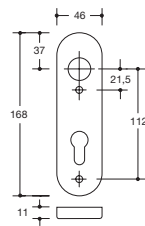

Schild 230...

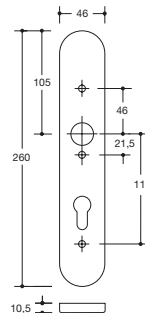

Schild 235...

ROSETTEN BICOLOR



Schlüsselrosette 306.23..I..

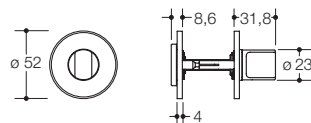

WC-Rosette 306..INR

ROSETTEN MINI

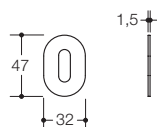

Schlüsselrosette 306P..M..

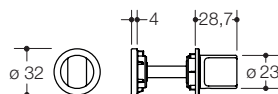

WC-Rosette 306P..MNR

SYSTEM 111 MINI

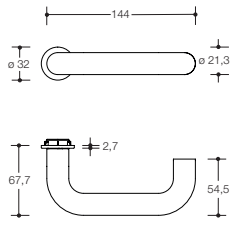

Modell 111XAM

SYSTEM 162 MINI

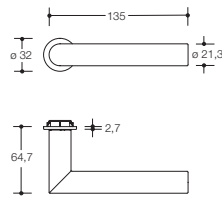

Modell 162X..M

SERIE 270 MINI

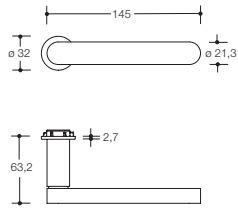

Modell 270X..M

TÜRDRÜCKER SYSTEM 111

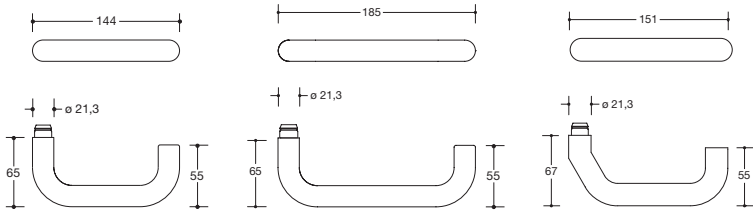

Modell 111X...

Modell 112X...

Modell 113X...

TÜRDRÜCKER SYSTEM 162

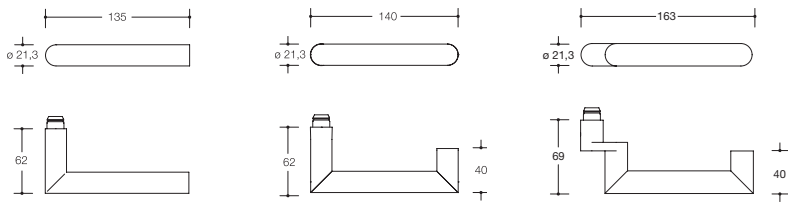

Modell 162X...

Modell 165X...

Modell 166X...

TÜRDRÜCKER SERIE 170

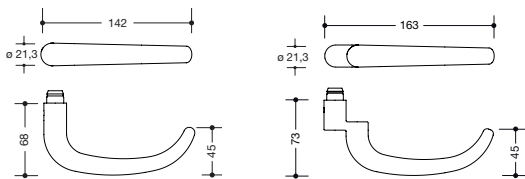

Modell 173X

Modell 174X

TÜRDRÜCKER SERIE 270

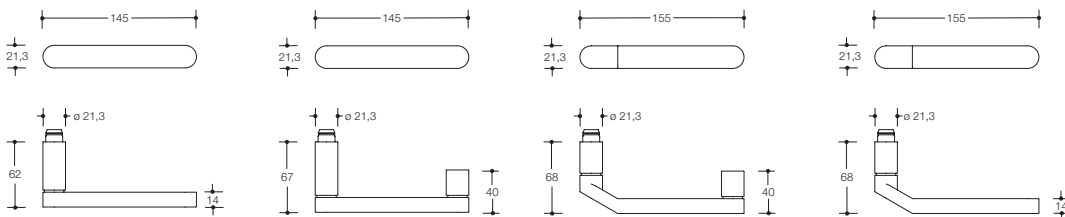

Modell 271X...

Modell 272X...

Modell 273X...

Modell 274X...

KNÖPFE

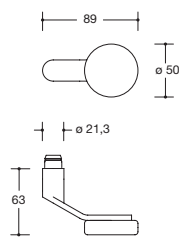

Modell 106X...

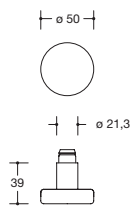

Modell 107X...

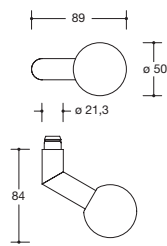

Modell 108X...

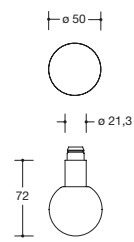

Modell 109X...

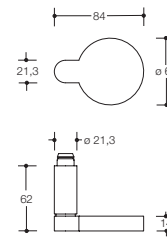

Modell 276X...

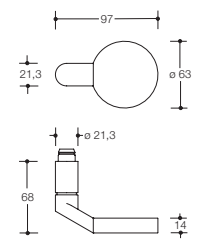

Modell 277X...

ROSETTEN MINI

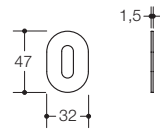

Schlüsselosette mini
306XAM

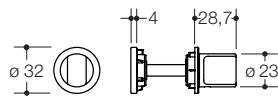

WC-Rosette mini
306XAMNR

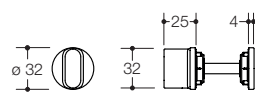

WC-Rosette mini
306XAMNRHT

ROSETTEN

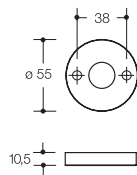

Drückerosette
305...X...

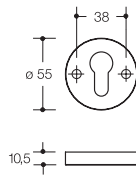

Schlüsselosette
306X.23X...

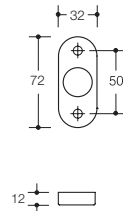

Drückerosette
315...X

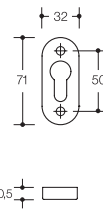

Schlüsselosette
316X../FS

SCHUTZROSETTEN

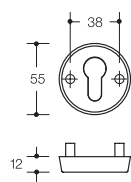

Schutzrossette
306.23X..ES...

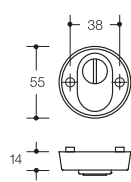

Schutzrossette
306.23X..ESZ...

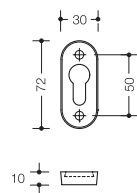

Schutzrossette
316X..ES...

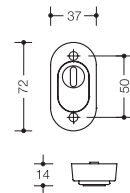

Schutzrossette
316X..ESZ

SCHILDER

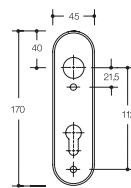

Schild
230...X...

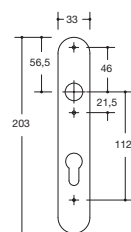

Schild
219.21X..H

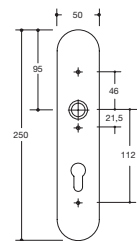

Schild
235.21X...

Innentüren (Vollblatttüren)

Zimmergarnitur

Zu verwendende Komponenten

Bauteil	Menge
Drückerlochteile	2 Stück
Drückerrosetten H/R-Technik	1 Paar
Schlüsselrosetten	1 Paar
Alternativ Schilder H/R-Technik	1 Paar
Stift 69.6B H-Technik	1 Stück
Stift 60.9R R-Technik	1 Stück

Frei-Besetzt-Garnitur

Zu verwendende Komponenten

Bauteil	Menge
Drückerlochteile	2 Stück
Drückerrosetten H/R-Technik	1 Paar
WC-Rosetten	1 Paar
Alternativ WC-Schilder H/R-Technik	1 Paar
Stift 69.6B H-Technik	1 Stück
Stift 60.9R R-Technik	1 Stück

Wechselgarnitur

Zu verwendende Komponenten

Bauteil	Menge
Drückerlochteil	1 Stück
Knopflochteil VK 9 mm	1 Stück
Drückerrosetten H/R-Technik	1 Paar
Schlüsselrosetten	1 Paar
Alternativ Schilder H/R-Technik	1 Paar
Stift 79.6B H-Technik	1 Stück
Stift 70.9R R-Technik	1 Stück

Halbgarnitur

Zu verwendende Komponenten

Bauteil	Menge
Drückerlochteil	1 Stück
Drückerrosetten H/R-Technik	1 Stück
Schlüsselrosetten	1 Paar
Alternativ Schilder	1 Stück
Stift 72.7B H-Technik	1 Stück
Stift 72.9R R-Technik	1 Stück

Feuer- und Rauchschutztüren

Feuerschutzgarnitur

Zu verwendende Komponenten

Bauteil	Menge
Drückerlochteile VK 9 mm	2 Stück
Drückerrosetten H/R-Technik	1 Paar
FS-Schlüsselrosetten	1 Paar
Alternativ FS-Schilder	1 Paar
Stift 69.6B H-Technik	1 Stück
Stift 60.9R R-Technik	1 Stück

Feuerschutzgarnitur mit geteiltem Stift

Zu verwendende Komponenten

Bauteil	Menge
Drückerlochteile VK 9 mm	2 Stück
Drückerrosetten H/R-Technik	1 Paar
FS-Schlüsselrosetten	1 Paar
Alternativ FS-Schilder H/R-Tech.	1 Paar
Stift 72.3R H/R-Technik	1 Stück

Feuerschutz-Wechselgarnitur

Zu verwendende Komponenten

Bauteil	Menge
Drückerlochteil VK 9 mm	1 Stück
Knopflochteil VK 9 mm	1 Stück
Drückerrosetten H/R-Technik	1 Paar
FS-Schlüsselrosetten	1 Paar
Alternativ FS-Schilder H/R-Technik	1 Paar
Stift 79.6B H-Technik	1 Stück
Stift 70.9R R-Technik	1 Stück

Spezifische Angaben

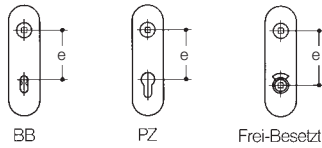

Lochungen/Entfernungen

Messen Sie die Entfernung bei Schließern und Beschlägen. Folgende Entfernungen sind üblich:
 BB = Bundbart e = 72 mm bei Zimmer- und Korridorüren
 PZ = Profizylinder e = 72 mm bei Zimmer- und Korridorüren oder 92 mm bei Haustüren
 Frei-Besetzt e = 78 mm

Weitere Lochungen/Entfernungen auf Anfrage.
 Bei Bestellung oder Ausschreibung von Rosettengarnituren ist die Angabe der Entfernung nicht erforderlich.

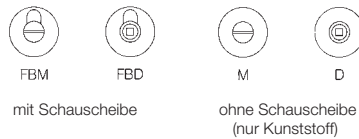

Notöffnungsarten bei Frei/Besetzt-Garnituren

FBM und M sind mit Münze, FBD und D mit Vierkantdornschlüssel zu öffnen.
 HEWI liefert als Standard FBM.

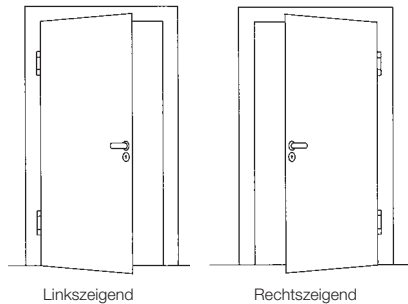

Links- und rechtsseitig für Türbeschläge

Bei Drückern mit Knopf 138 und Serie 270:
 Die Drücker sind rechts- oder linksseitig (abhängig von der Öffnungsrichtung der Tür).
 Rechtsseitig bedeutet: das Drückerende zeigt nach rechts.

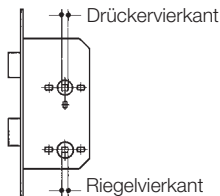

Drücker- und Riegelvierkant

Lieferbare Drücker- und Riegelvierkant: 7, 8, 8,5, 9 und 10/8 mm.

Riegelvierkant bei Badzellen- oder WC-Türschloss 7 oder 8 mm.

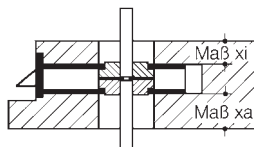

Maß „x innen“ und „x außen“

bei Feuerchutzgarnitur mit geteiltem Stift

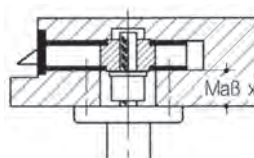

Maß „x“

bei Halbgarnituren

Bestellangaben

- **Bestellnummer**
- **Oberfläche**
bei Produkten aus Edelstahl
- **Farbe**
bei Produkten aus Polyamid
- **Lochung bzw. Notöffnungsart**
bei Frei-Besetzt-Garnituren (siehe links)
- **Maß x**
bei Halbgarnituren (Erklärung siehe unten)
- **Maß „x innen“, Maß „x außen“**
bei Feuerchutzgarnituren mit geteiltem Stift (Erklärung siehe unten)
- **Entfernung**
bei Verwendung von Schildern (übliche Maße siehe nebenstehende Abbildung)
- **Drücker rechts- oder linksseitig**
- **Drückervierkant**
- **Türstärke**

Entfernungen für Schweiz und Österreich sind nicht aufgeführt.

Standardbelegungen Edelstahl | Polyamid

Sofern nur die Artikelnummer bei der Bestellung angegeben wird, gehen wir von folgender Standardbelegung aus:

1. Zimmergarnituren: TS = 40 mm, VK = 8 mm, Lochung PZ, Entfernung = 72 mm bei Schildgarnitur
2. Feuerchutzgarnituren: TS = 48 mm, VK = 9 mm, Lochung PZ, Entfernung = 72 mm bei Schildgarnitur
3. Frei-Besetzt-Garnituren: TS = 40 mm, VK = 8 mm, Notöffnungsart mit Münze, Entfernung = 78 mm bei Schildgarnitur